

Simple Weighing Scale

DL Series

OWNER'S MANUAL



9002-DL1-0033-0

2005.9

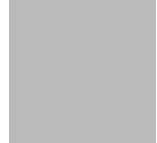

CONTENTS

PRECAUTIONS	4
PREFACE	6
NAMES AND FUNCTIONS	6
INSTALLATIONS	8
OPERATIONS	9
1. General Weighing	9
2. Weighing with Tare	10
3. Changing Unit of Weight	10
4. HOLD Function	11
5. Comparator Function	11
6. Counting Function	13
7. AUTO Power Off Function	15
BATTERY MAINTENANCE	16
ERROR MESSAGE	16
SPECIFICATIONS	17

PRECAUTIONS

Make sure that you plug your scale into the proper power outlet.
Plug into a power outlet 30 minutes before operations.

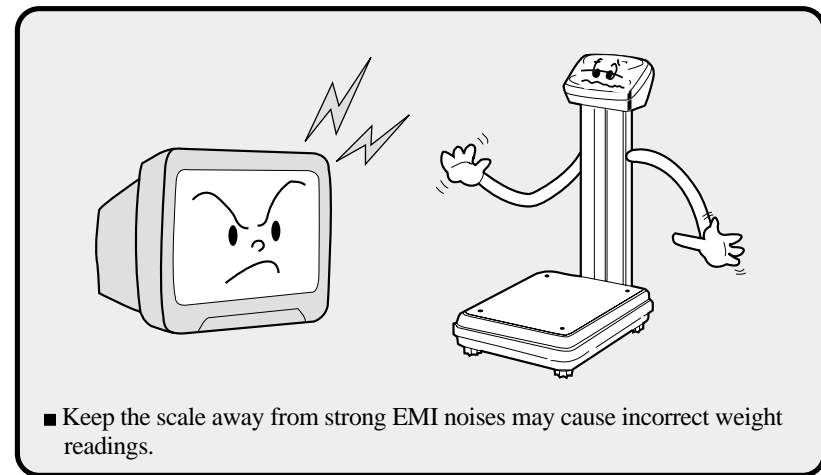
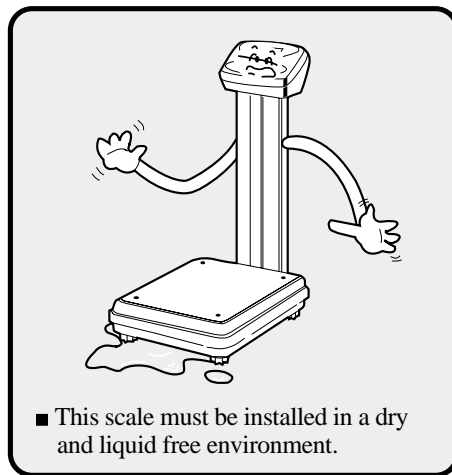
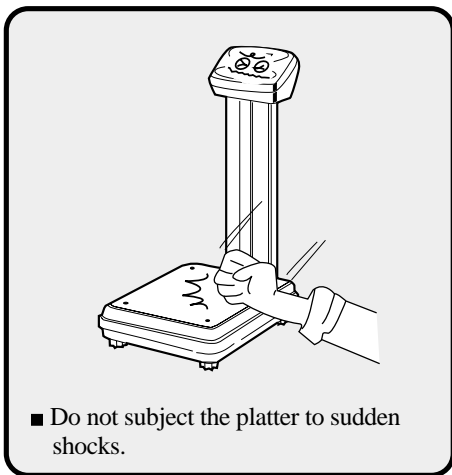
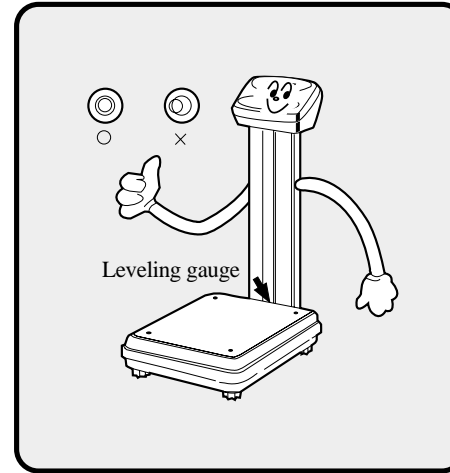
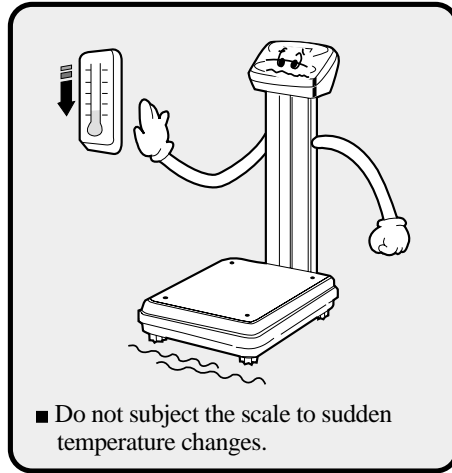
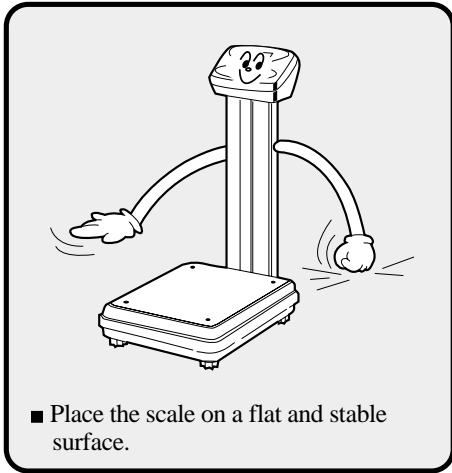

PREFACE

Thank you for purchasing our CAS DL series.

These series have been designed with CAS reliability, under rigid quality control and with outstanding performance. Your specialty departments can enjoy these high quality reliable CAS products.

We believe that your needs will be satisfied and you will have reliability.

This manual will help you with proper operation and care of the DL series.

Please keep this handy for future reference.

NAMES AND FUNCTIONS

OVERALL VIEW

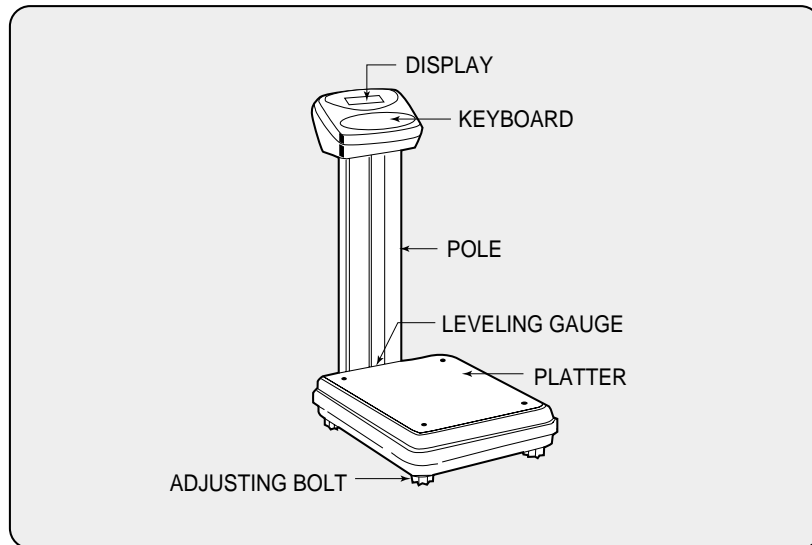

DISPLAY AND KEYBOARD

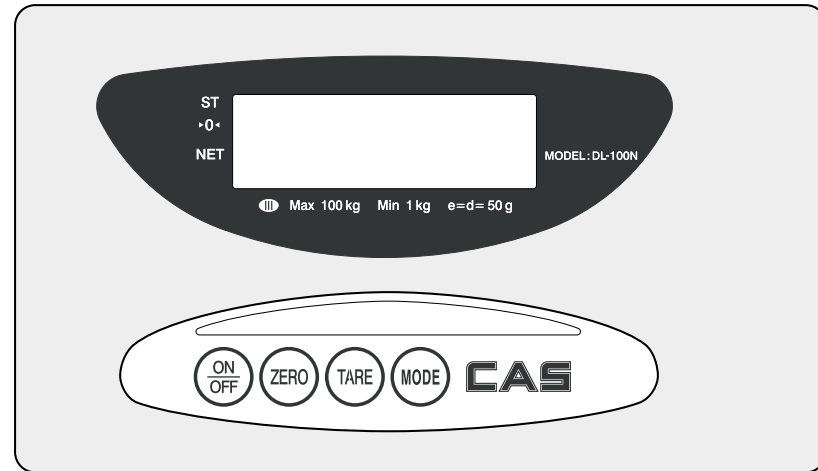

■ KEY FUNCTIONS

KEYS	FUNCTIONS
	Used to set the zero point.
	Used to input or cancel the weight of tare.
	Used to change the unit of weight, and shown as following sequence on the display. [WEIGHT]—[HOLD]—[WL on or off]—[PCS]—[WEIGHT]
	Used to turn on and off the scale.

INSTALLATIONS

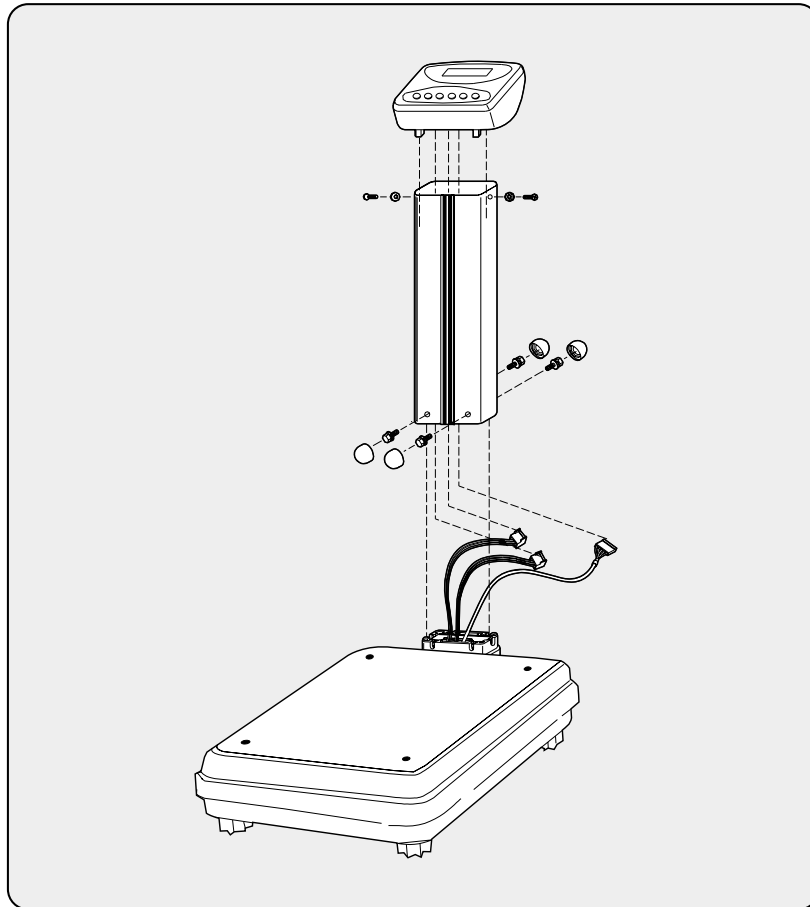

1. Insert and fasten the bracket support assembly screws.
2. Connect the load cell wire and power line to head.
3. Insert the support cover into the support.
4. Insert and fasten the screws.

OPERATIONS

- Turn on the display by pressing the ON/OFF key. Then the display will show all the segments and count up "0" to "9". You may stop this automatic counting by pressing the ZERO key.
- When you turn on the display, make sure that platter is empty. Otherwise, display will show "Err", an error of initial zero range. Please refer "ERROR MESSAGE" section for more information on page 16.
- When the weight becomes stable the display shows the stable sign(0) on.
- You may need to make it "0.00" by pressing the ZERO key unless the display indicate "0.00" under the empty platter.

1. General Weighing

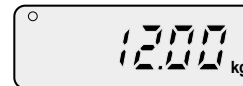

- ① Place a commodity on the platter.

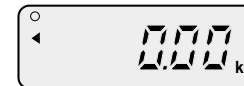

- ② Remove the commodity from the platter.

2. Weighing with Tare

- TARE means the weight of container being used for a commodity.
- TARE key function is to subtract the weight of the container from full weight loaded.

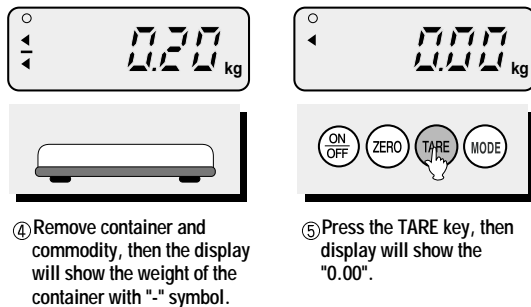

3. Changing Unit of Weight (kg, lb, oz)

- Press the MODE key first. Holding it, press the TARE key in the simple weighing mode. The display shows the "UnIt" shortly and then you may select kg, lb, or oz as the unit of weight.

4. HOLD Function

- When the weight is not stable, press the MODE key. The display shows the "HOLD" and then press ZERO key. The display will show average weight.

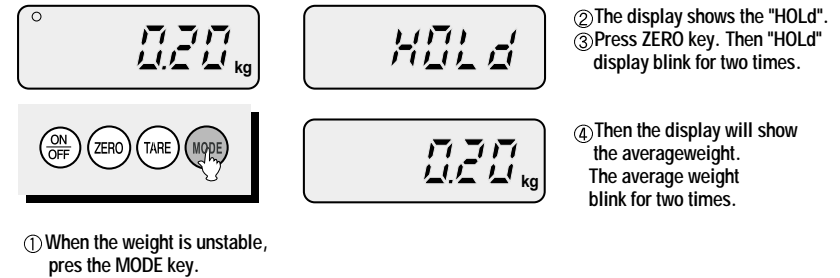

*NOTE: Stable indication(0) will not display in HOLD mode.

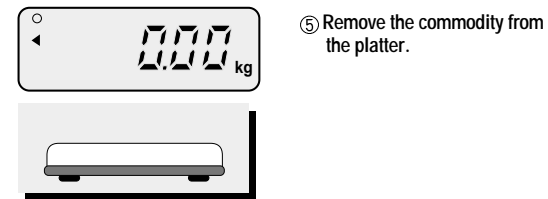

5. Comparator Function - HI / LOW Limit Setting

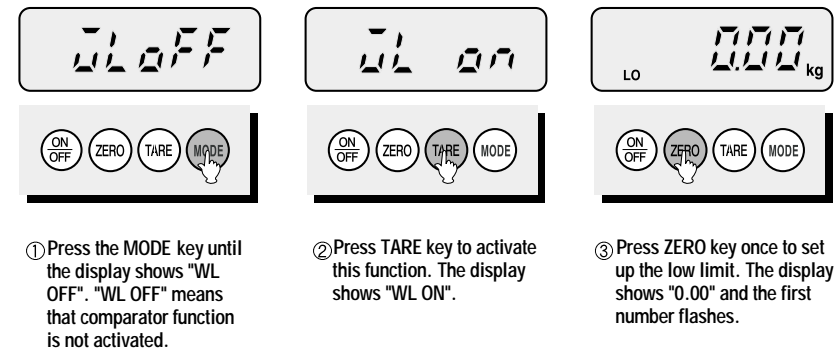

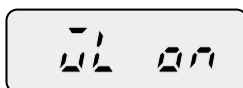
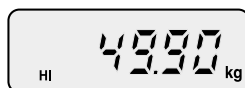
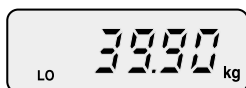

④ Press the MODE key to have number increase. To move flash to next digit, press the TARE key.

⑤ Press ZERO key to set up HIGH limit. The display shows "0.00" and you can change these numbers by pressing MODE key. If you want to move to next digit you can go by pressing TARE key.

⑥ If you set up HIGH limit you can go out by pressing ZERO key, and you can see "ENd" message shortly and "WL on" message on the display.

⑦ If you set up HIGH limit and LOW limit incorrectly, "Err" will be shown on the display. Then you may need to set it up again. For example, LOW LIMIT=39.90 kg and HIGH LIMIT=49.90 kg this is incorrect setting because HIGH limit is lower than the LOW limit. When HIGH and LOW limit are set as the same or above maximum capacity it still shows "Err" message.

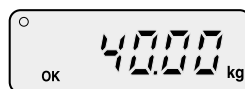
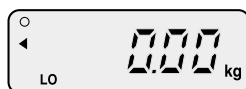

⑧ If you want to go back to the simple weighing mode just press MODE key twice.

⑨ Suppose that the HIGH limit and LOW limit are set up as 49.90kg and 39.90kg respectively. If the weight loaded is 2kg between HIGH and LOW limit the display shows "OK" and the scale continues to beep slowly. If the weight loaded is above 49.90kg, HIGH limit, the scale continues to beep rapidly.

6. Counting Function

■ Counting without Tare

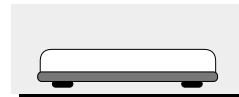
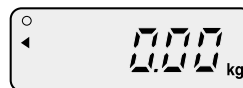

① Initial display as above.

② Press MODE key three times to go to sample unit selection mode.

③ Press ZERO key to select the number of sample unit. You can select 10, 20, 30, 40, 50, 60, 70, 80, 90, 100, 200, 300, 400, or 500 as a sample unit.

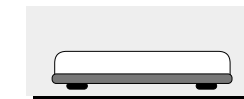
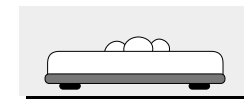
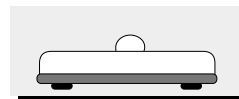
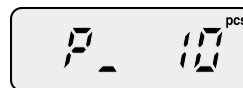

④ If you select "P_10" as a sample unit, then please put 10 sample units on the scale. Then press TARE key to set sample units.

⑤ Put all of commodities you wish to count, and then check the number of pieces on display.

⑥ Remove all of commodities from the scale.

■ Counting with Tare

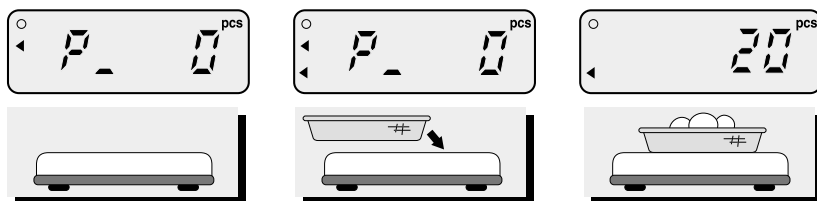

- ① Press MODE key twice to go to sample unit selection mode. "PCS" is shown on the display, then press ZERO key to select the number of sample unit.
- ② Put the container on the scale and press TARE key to set weight of tare. You can select 10, 20, 30, 40, 50, 60, 70, 80, 90, 100, 200, 300, 400, or 500 as a sample unit, by pressing ZERO key.
- ③ If the number of selected sample unit is 20, please put 20 sample units on the scale. Then press TARE key to set unit weight.

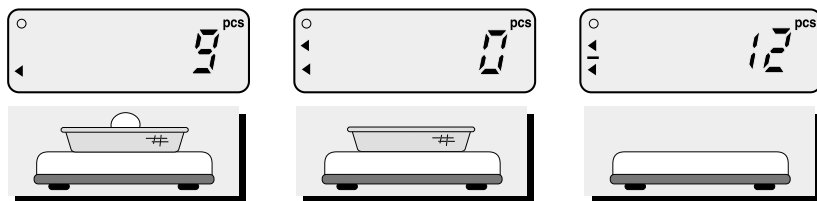

- ④ Put all of commodities you wish to count, and then count the number on display.
- ⑤ Remove all of commodities from the scale.
- ⑥ Remove the tare from the platter.

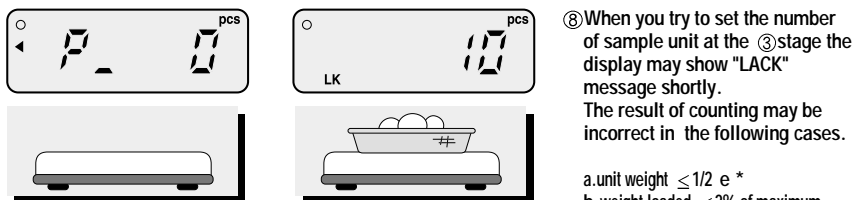

- ⑦ Press "Zero" key and then press "Tare" key to exit from tare function.

- ⑧ When you try to set the number of sample unit at the ③ stage the display may show "LACK" message shortly. The result of counting may be incorrect in the following cases.

- a. unit weight $\leq 1/2 e^*$
- b. weight loaded $\leq 2\%$ of maximum weighing capacity.

*"e" value may be various on capacity of product model.

Please refer to "SPECIFICATION" on page 18. For example, a product model which capacity is 60.00kg has 0.02kg as "e" value

7. Auto Power Off Function

Auto-Power off function is to automatically power off as time is set. This function is helpful to save battery, which is not in use. The following is the setting procedure of Auto-power off.

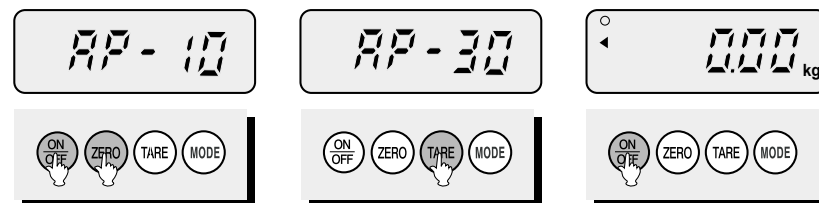

- ① When the scale is turned off press ON/OFF key, holding ZERO key. Then you will see the "AP-10". (If you have set this before, display will show previous value.)
- ② Press the TARE key until the display shows the "AP-x0" that you wish to take. (Refer to TABLE 1.)
- ③ Press the ON/OFF key, and then the scale saves what you programmed and shows all the segments, counting up "0" to "9".

TABLE 1.

DISPLAY	FUNCTION
AP-00	This function does not automatically power off.
AP-10	This function does automatically power off when the scale is not in use for 10 minutes.
AP-20	This function does automatically power off when the scale is not in use for 20 minutes.
AP-30	This function does automatically power off when the scale is not in use for 30 minutes.

BATTERY MAINTENANCE

LOW BATTERY WARNING

When the battery is low the display shows the "BAT" sign.

You can replace the battery new one.

If you still use the scale without replacing the battery the scale may provide incorrect result on measurement.

ERROR MESSAGE

ERROR	REASONS	SOLUTIONS
Err	An error of the initial zero range	Set the platter empty.
Init	Problems on Analog Module	Try to turn OFF and ON the scale. Call your CAS dealer if still problems.
OFL	Overload on the platter	Remove it from the platter Do not put something exceeding maximum capacity on the platter
UNStA	Unstable conditions of scale	Make the scale stable conditions

■ How to connect the ground wire.

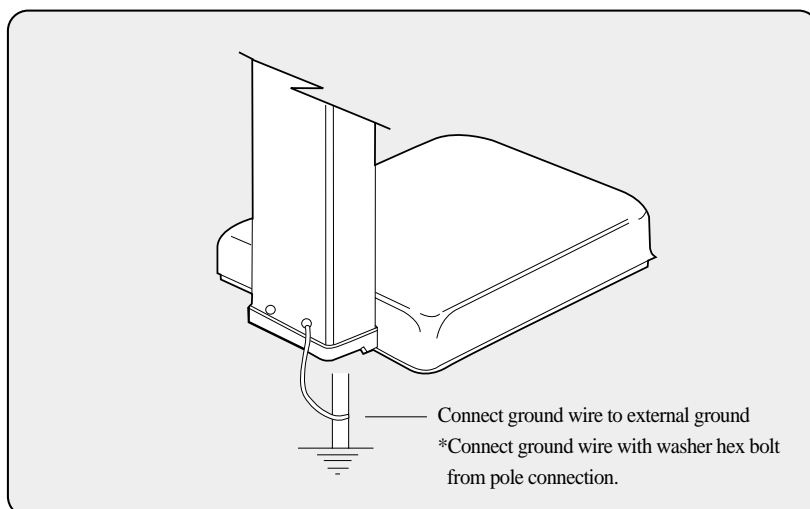

SPECIFICATIONS

MODEL	DL-60	DL-100	DL-150
CAPACITY	60.00kg	100.00kg	150.00kg
MIN. DIVISION	20g	50g	50g
INTERNAL RESOLUTION	1/30,000	1/20,000	1/30,000
EXTERNAL RESOLUTION	1/3,000	1/2,000	1/3,000
DISPLAY	5 digit LCD		
SYMBOLS	STABLE, ZERO, kg, lb, oz, BAT		
KEYS	ZERO, TARE, MODE, ON/OFF		
FUNCTIONS	General Weighing, Hold Function Counting Function, Comparator Function		
DIMENSIONS	365 × 620 × 730mm		420 × 655 × 710mm
PLATTER SIZE	355 × 465mm		395 × 520mm
WEIGHT	18kg		15kg
POWER	1.5V × 6 (option C size battery) or 9V adapter		
MINIMUM VOLTAGE OF THE BATTERY	about 5.8V		
TEMPERATURE	-10°C ~ 40°C		
OPTION	1.5V × 6 (C size battery is optional)		

*NOTE : Specifications are subject to change for improvement without notice

MEMO

MEMO

MEMO